

# EE16 Series

## Humidity / Temperature Transmitter for HVAC Applications

EE16 transmitters are the ideal solution for accurate measurement of relative humidity and temperature at a reasonable price in HVAC applications. The appropriate filter cap enables employment in heavily polluted environment.

The new developed E+E humidity sensors HC101 guarantee excellent long term stability and resistance against chemical pollutants. Their excellent reproducibility allows a simple low-cost-one-point calibration for very good accuracy over the entire working range.

EE16 transmitters are available as wall or duct mounted, with current or voltage output signals.



### Typical Applications

building-automation  
 storage rooms  
 climate and ventilation control

### Features

excellent price/performance ratio  
 wettable  
 long term stable

### Technical Data

#### Measuring values

##### Relative Humidity

Sensor	HC101	
Output appropriate 0...100% RH	0-10 V	-1 mA < I <sub>L</sub> < 1 mA
	4-20 mA (two wire)	R <sub>L</sub> < 500 Ohm
Working range <sup>1)</sup>	10...95% RH	
Accuracy at 20°C (68°F)	±3% RH	
Temperature dependence at 45% RH	typ. -0.05% RH / °C (-0.03% RH / °F)	

##### Temperature

Sensor	Pt1000 (class A, DIN EN 60751)	
Output appropriate 0...50°C (32...122°F)	0-10 V	-1 mA < I <sub>L</sub> < 1 mA
	4-20 mA (two wire)	R <sub>L</sub> < 500 Ohm
Accuracy at 20°C (68°F) <sup>2)</sup>	±0.3°C (±0.5°F)	

#### General

Supply voltage	15 - 35V DC or 24V AC ±20%	
for 0 - 10 V	10V + R <sub>L</sub> x 20 mA < U <sub>v</sub> < 35V DC	
for 4 - 20 mA		
Current consumption	for DC supply	typ. 8 mA
	for AC supply	typ. 20 mA <sub>eff</sub>
Electrical connection	screw terminals max. 1.5 mm <sup>2</sup> (AWG 16)	
Housing / protection class	Polycarbonat / IP65; Nema 4	
Cable gland	M16 x 1.5	cable Ø 4.5 - 10 mm (0.18 - 0.39")
Sensor protection	membrane filter, metal grid filter, stainless steel sintered filter	
Electromagnetic compatibility	EN 61000-6-1	EN 61326-1+A1+A2
	EN 61000-6-3	
Temperature range	working temperature:	-5...50°C (23...122°F)
	storage temperature:	-25...60°C (-13...140°F)

1) Please refer to working range of HC101

2) Please note: temperature accuracy EE16-x6xx2x: ±0.5°C (±0.9°F)



## Housing Dimensions (mm)

1 mm = 0.03937" / 1" = 25.4 mm

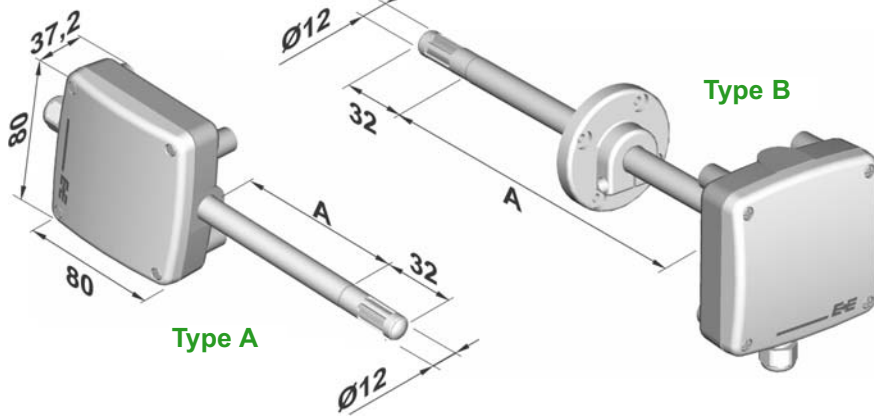

## Connection Diagram

### EE16-FT3xxx

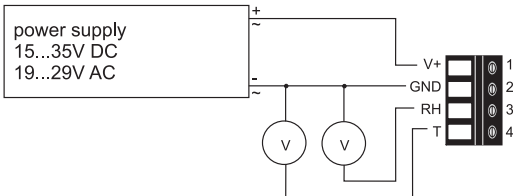

### EE16-FT6xxx

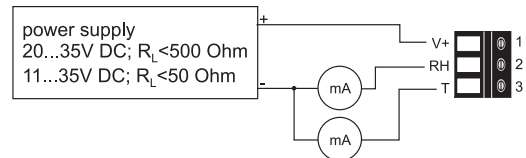

### EE16-F3xxx

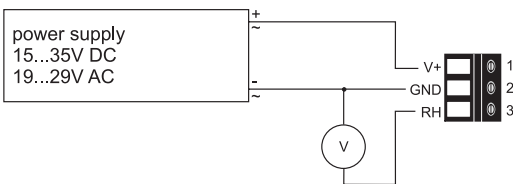

### EE16-F6xxx

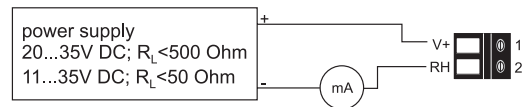

### EE16-FP3xxx

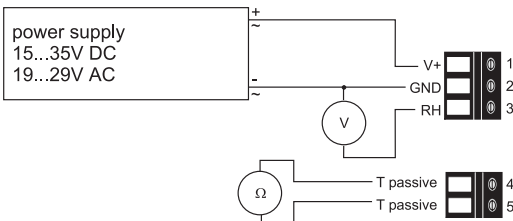

### EE16-FP6xxx

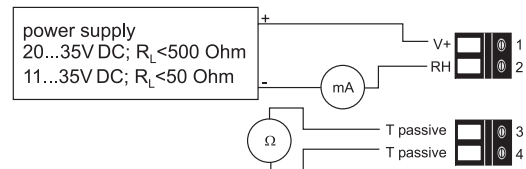

## Ordering Guide

MODEL	OUTPUT	T-Sensor (only model FP)	HOUSING	PROBE LENGTH (according to "A")	FILTER
humidity + temperature (FT)	0-10V (3) 4-20 mA (6)	Pt 100 DIN A (A) Pt 100 DIN B (B)	wall mounting (A) duct mounting (B)	50 mm (1.9") (2) 200 mm (7.9") (5)	membrane filter (1) sintered stainless
humidity (F)		Pt 1000 DIN A (C)			steel filter (3)
humidity + temperature passive (FP)		Pt 1000 DIN B (D) others on request			metal grid (6)
EE16-					

## Order Example

### EE16-F3A21

model: humidity transmitter  
 output: 0-10V  
 housing: wall mounting  
 probe length: 50 mm (1.9")  
 filter: membrane filter