

PEN Experiment: A Sensitive Search for Non-(V-A) Weak Processes

Dinko Počanić (for the PEN Collaboration)

University of Virginia

PANIC 2008, Eilat, Israel
9-14 Nov 2008

Outline

Motivation

- The PIBETA–PEN program
- SM calculations; mass limits
- Lepton universality

Overview of the PEN Experiment

- The apparatus and method

Brief look at 2007 and 2008 results

- Sample waveforms and histograms

Summary: present status, plans

The PIBETA-PEN Program of Measurements

Perform precision checks of Standard Model and QCD predictions:

_____ 1st phase: The **PIBETA** experiment _____

- ▶ $\pi^+ \rightarrow \pi^0 e^+ \nu_e$
 - SM checks related to CKM unitarity
- ▶ $\pi^+ \rightarrow e^+ \nu_e \gamma$ (or $e^+ e^-$)
 - F_A/F_V , π polarizability (χ PT prediction)
 - tensor coupling besides $\mathbf{V} - \mathbf{A}$ (?)
- ▶ $\mu^+ \rightarrow e^+ \nu_e \bar{\nu}_\mu \gamma$ (or $e^+ e^-$)
 - departures from $\mathbf{V} - \mathbf{A}$ in $\mathcal{L}_{\text{weak}}$

_____ 2nd phase: The **PEN** experiment _____

- ▶ $\pi^+ \rightarrow e^+ \nu_e$
 - e - μ universality
 - pseudoscalar coupling besides $\mathbf{V} - \mathbf{A}$
 - ν sector anomalies, Majoron searches, \mathbf{m}_{h^+} , PS \mathbf{l} - \mathbf{q} 's, V \mathbf{l} - \mathbf{q} 's, ...

Known and Measured Pion and Muon Decays

Decay	BR		
$\pi^+ \rightarrow \mu^+ \nu$	0.9998770 (4)	$(\pi_{\mu 2})$	
$\mu^+ \nu \gamma$	$2.00 (25) \times 10^{-4}$	$(\pi_{\mu 2 \gamma})$	
$e^+ \nu$	$1.230 (4) \times 10^{-4}$	$(\pi_{e 2})$	✓
$e^+ \nu \gamma$	$1.61 (23) \times 10^{-7}$	$(\pi_{e 2 \gamma})$	✓
$\pi^0 e^+ \nu$	$1.025 (34) \times 10^{-8}$	$(\pi_{e 3}, \pi_{\beta})$	✓
$e^+ \nu e^+ e^-$	$3.2 (5) \times 10^{-9}$	$(\pi_{e 2 ee})$	
$\pi^0 \rightarrow \gamma \gamma$	0.98798 (32)		
$e^+ e^- \gamma$	$1.198 (32) \times 10^{-2}$		
$e^+ e^- e^+ e^-$	$3.14 (30) \times 10^{-5}$		
$e^+ e^-$	$6.2 (5) \times 10^{-8}$		
$\mu^+ \rightarrow e^+ \nu \bar{\nu}$	~ 1.0		
$e^+ \nu \bar{\nu} \gamma$	0.014 (4) ✓		
$e^+ \nu \bar{\nu} e^+ e^-$	$3.4 (4) \times 10^{-5}$		

$\pi \rightarrow e\nu$ Decay: SM Calculations; Measurements

Modern theoretical calculations: $B_{\text{calc}} = \frac{\Gamma(\pi \rightarrow e\bar{\nu}(\gamma))}{\Gamma(\pi \rightarrow \mu\bar{\nu}(\gamma))_{\text{calc}}} =$

$$\left\{ \begin{array}{l} 1.2352(5) \times 10^{-4} \quad \text{Marciano and Sirlin, [PRL 71 (1993) 3629]} \\ 1.2356(1) \times 10^{-4} \quad \text{Decker and Finkemeier, [NP B 438 (1995) 17]} \\ 1.2352(1) \times 10^{-4} \quad \text{Cirigliano and Rosell, [PRL 99, 231801 (2007)]} \end{array} \right.$$

Experiment, world average [current PDG]:

$$\frac{\Gamma(\pi \rightarrow e\bar{\nu}(\gamma))}{\Gamma(\pi \rightarrow \mu\bar{\nu}(\gamma))_{\text{exp}}} = (1.230 \pm 0.004) \times 10^{-4}$$

N.B.:

$$\text{PEN goal: } \frac{\delta B}{B} \simeq 5 \times 10^{-4}.$$

$\pi \rightarrow e\nu$ Decay: SM Calculations; Measurements

Modern theoretical calculations: $B_{\text{calc}} = \frac{\Gamma(\pi \rightarrow e\bar{\nu}(\gamma))}{\Gamma(\pi \rightarrow \mu\bar{\nu}(\gamma))_{\text{calc}}} =$

$$\left\{ \begin{array}{ll} 1.2352(5) \times 10^{-4} & \text{Marciano and Sirlin, [PRL 71 (1993) 3629]} \\ 1.2356(1) \times 10^{-4} & \text{Decker and Finkemeier, [NP B 438 (1995) 17]} \\ 1.2352(1) \times 10^{-4} & \text{Cirigliano and Rosell, [PRL 99, 231801 (2007)]} \end{array} \right.$$

Experiment, world average [current PDG]:

$$\frac{\Gamma(\pi \rightarrow e\bar{\nu}(\gamma))}{\Gamma(\pi \rightarrow \mu\bar{\nu}(\gamma))_{\text{exp}}} = (1.230 \pm 0.004) \times 10^{-4}$$

N.B.:

PEN goal: $\frac{\delta B}{B} \simeq 5 \times 10^{-4}$.

$\pi \rightarrow e\nu$ Decay: SM Calculations; Measurements

Modern theoretical calculations: $B_{\text{calc}} = \frac{\Gamma(\pi \rightarrow e\bar{\nu}(\gamma))}{\Gamma(\pi \rightarrow \mu\bar{\nu}(\gamma))_{\text{calc}}} =$

$$\left\{ \begin{array}{l} 1.2352(5) \times 10^{-4} \quad \text{Marciano and Sirlin, [PRL 71 (1993) 3629]} \\ 1.2356(1) \times 10^{-4} \quad \text{Decker and Finkemeier, [NP B 438 (1995) 17]} \\ 1.2352(1) \times 10^{-4} \quad \text{Cirigliano and Rosell, [PRL 99, 231801 (2007)]} \end{array} \right.$$

Experiment, world average [current PDG]:

$$\frac{\Gamma(\pi \rightarrow e\bar{\nu}(\gamma))}{\Gamma(\pi \rightarrow \mu\bar{\nu}(\gamma))_{\text{exp}}} = (1.230 \pm 0.004) \times 10^{-4}$$

N.B.:

PEN goal: $\frac{\delta B}{B} \simeq 5 \times 10^{-4}$.

π_{e2} Decay and the SM

$B(\pi \rightarrow e\nu) = \Gamma(\pi_{e2})/\Gamma(\pi_{\mu2})$ given in SM to 10^{-4} accuracy; dominated by helicity suppression ($V - A$). Deviations from this rate can be caused by:

- (a) charged Higgs in theories with richer Higgs sector than SM,
- (b) PS leptoquarks in theories with dynamical symmetry breaking,
- (c) V leptoquarks in Pati-Salam type GUT's,
- (d) loop diagrams involving certain SUSY partner particles,
- (e) non-zero neutrino masses (and mixing).

Proc's. (a)–(d) \Rightarrow PS currents. Most general 4-fermion π_{e2} amplitude:

$$\frac{G_F}{\sqrt{2}} \left[(\bar{d}\gamma_\mu\gamma^5 u) (\bar{\nu}_e\gamma^\mu\gamma^5(1 - \gamma^5)e) f_{AL}^e + f_{PL}^e (\bar{d}\gamma^5 u) (\bar{\nu}_e\gamma^5(1 - \gamma^5)e) \right] + \text{r.h. } \nu \text{ term}$$

In the SM: $f_{AL}^\ell = 1$, while $f_{XR}^\ell = f_{PX}^\ell = 0$, with $\ell = e, \mu$.

The f_{PL}^e and Mass Bounds

Allowing for pseudoscalar coupling [Shanker, NP B204 (82) 375]:

$$B_{\pi e 2} = B_{\text{SM}} \left(1 + \frac{2m_{\pi} a_{\text{P}}}{m_e a_{\text{A}}} f_{\text{PL}}^e \right) / \left(1 + \frac{2m_{\pi} a_{\text{P}}}{m_{\mu} a_{\text{A}}} f_{\text{PL}}^{\mu} \right),$$

where 2nd term in denominator is negligible because $f_{\text{PL}}^e \simeq f_{\text{PL}}^{\mu}$, while

$$\frac{a_{\text{P}}}{a_{\text{A}}} \simeq \frac{m_{\pi}}{m_u + m_d} \simeq 14.$$

Therefore

$$\left(B_{\pi e 2}^{\text{obs}} - B_{\pi e 2}^{\text{SM}} \right) / B_{\pi e 2}^{\text{SM}} = \frac{\Delta B}{B^{\text{SM}}} \simeq \frac{2m_{\pi} a_{\text{P}}}{m_e a_{\text{A}}} f_{\text{PL}}^e \simeq 7700 f_{\text{PL}}^e !$$

Tgt accuracy of the PEN experiment is $\Delta B/B \simeq 5 \times 10^{-4}$, which gives a 1σ sensitivity of

$$\delta f_{\text{PL}}^e \simeq 6.5 \times 10^{-8}.$$

We can use this sensitivity to get estimates of the mass reach of PEN.

Mass Bounds from PEN Goal Accuracy

- (a) Charged Higgs, m_{H^+} [Shanker, NP B204 (82) 375]

Given a mixing angle suppression $S \approx 10^{-2}$, we get

$$f_{\text{PL}}^e \approx S \frac{m_t m_\tau}{m_{H^+}^2} \quad \text{yielding} \quad m_{H^+} > 6.9 \text{ TeV}.$$

- (b) Pseudoscalar leptoquarks, m_P

Given an estimated effective Yukawa coupling of $y \simeq 1/250$, we can find m_P , mass of the color-triplet PS l - q :

$$f_{\text{PL}}^e \approx \frac{\sqrt{2}}{G_F} \frac{y^2}{2m_P^2} \quad \text{yielding} \quad m_P > 3.8 \text{ TeV}.$$

- (c) Vector leptoquarks, M_G

Following Shanker who assumes gauge coupling $g \simeq g_{\text{SU}(2)}$, we get:

$$f_{\text{PL}}^e \approx \frac{4M_W^2}{M_G^2} \quad \text{yielding} \quad M_G > 630 \text{ TeV}.$$

Lepton Universality (and Neutrinos)

From

$$R_{e/\mu} = \frac{\Gamma(\pi \rightarrow e\bar{\nu}(\gamma))}{\Gamma(\pi \rightarrow \mu\bar{\nu}(\gamma))} = \frac{g_e^2}{g_\mu^2} \frac{m_e^2}{m_\mu^2} \frac{(1 - m_e^2/m_\mu^2)^2}{(1 - m_\mu^2/m_\pi^2)^2} (1 + \delta R_{e/\mu})$$

$$R_{\tau/\pi} = \frac{\Gamma(\tau \rightarrow e\bar{\nu}(\gamma))}{\Gamma(\pi \rightarrow \mu\bar{\nu}(\gamma))} = \frac{g_\tau^2}{g_\mu^2} \frac{m_\tau^3}{2m_\mu^2 m_\pi} \frac{(1 - m_\pi^2/m_\tau^2)^2}{(1 - m_\mu^2/m_\pi^2)^2} (1 + \delta R_{\tau/\pi})$$

one can evaluate

$$\left(\frac{g_e}{g_\mu}\right)_\pi = 1.0021 \pm 0.0016 \quad \text{and} \quad \left(\frac{g_\tau}{g_\mu}\right)_{\pi\tau} = 1.0030 \pm 0.0034.$$

For comparison

$$\left(\frac{g_e}{g_\mu}\right)_W = 0.999 \pm 0.011 \quad \text{and} \quad \left(\frac{g_\tau}{g_e}\right)_W = 1.029 \pm 0.014.$$

[Violation of LU at presently allowed level would account for “NuTeV anomaly.”]

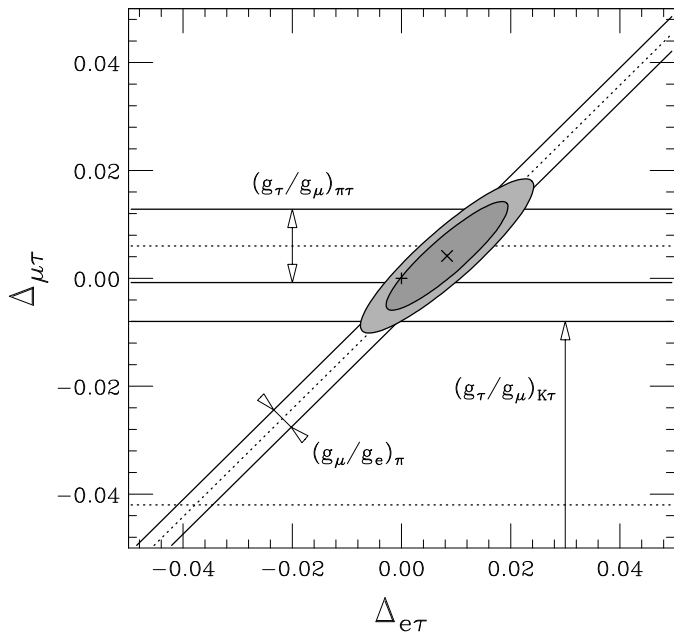

From
Loinaz et al.,
PRD **70** (2004)
113004

$$\Delta_{\ell\ell'} = 2 \frac{g_\ell}{g_{\ell'}}$$

The PIBETA/PEN Apparatus

- stopped π^+ beam
- active target counter
- 240-det. CsI(p) calo.
- central tracking
- digitized PMT signals
- stable temp./humidity

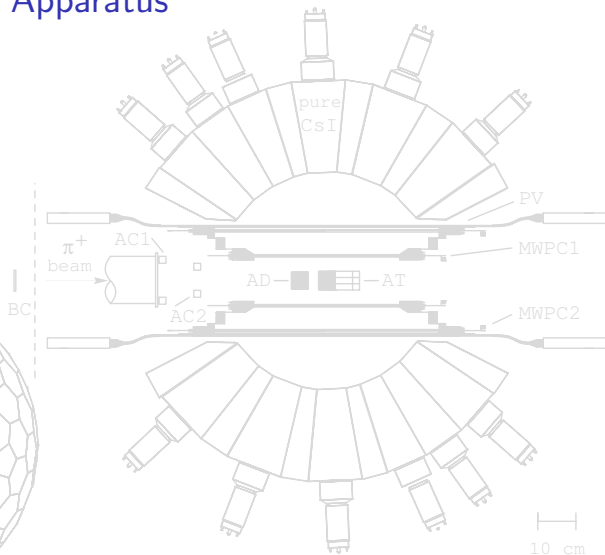
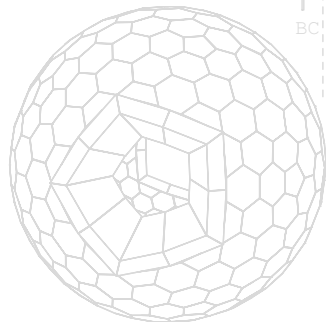

The PIBETA/PEN Apparatus

- stopped π^+ beam
- active target counter
- 240-det. CsI(p) calo.
- central tracking
- digitized PMT signals
- stable temp./humidity

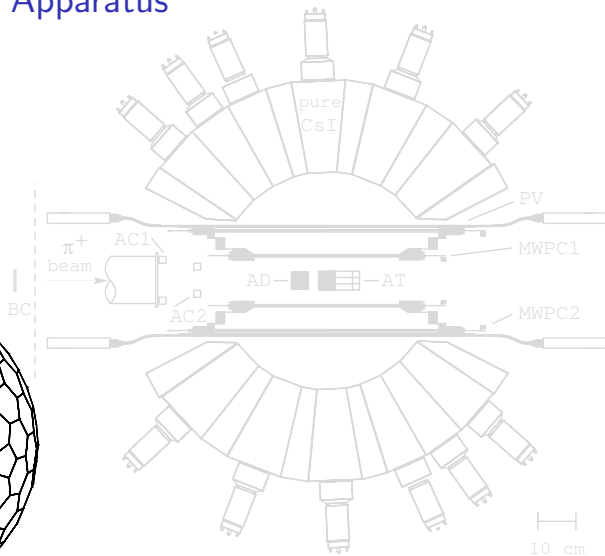
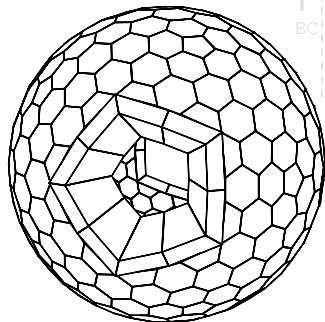

The PIBETA/PEN Apparatus

- stopped π^+ beam
- active target counter
- 240-det. CsI(p) calo.
- central tracking
- digitized PMT signals
- stable temp./humidity

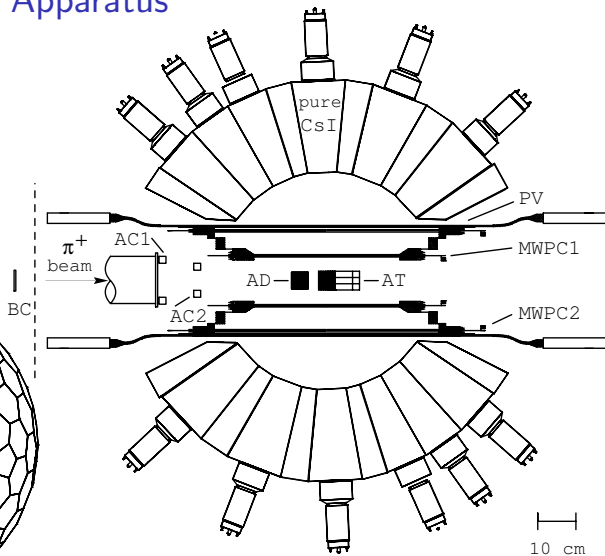
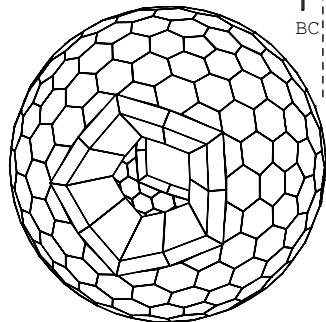

Central Detectors: 2007 Engineering Run

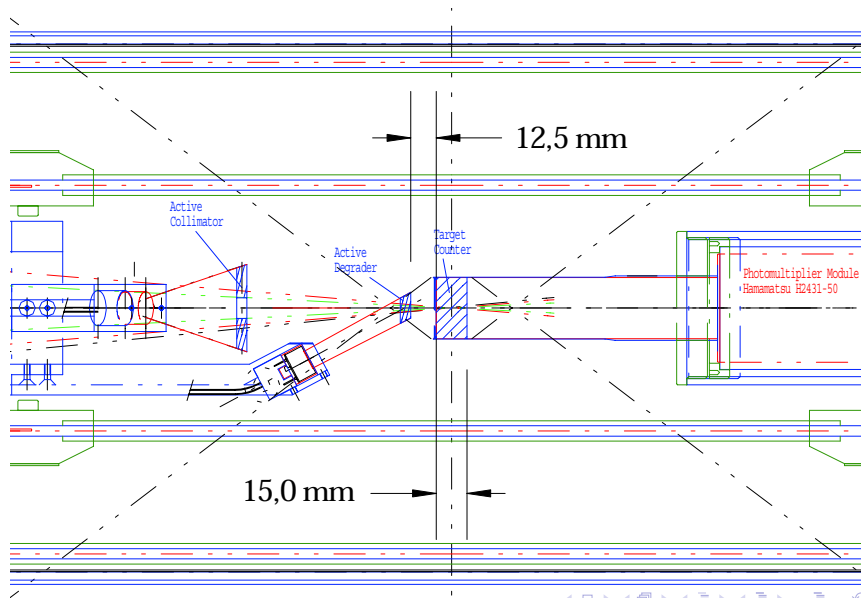

Wedged Degradator: 2008 Run

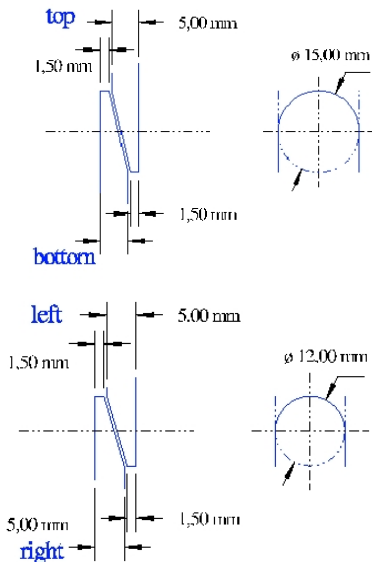
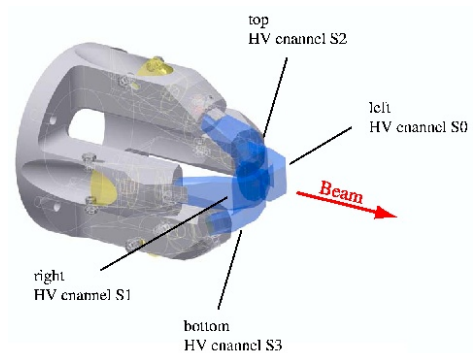

Timing in the central beam detectors

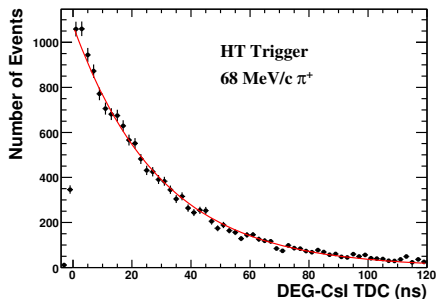
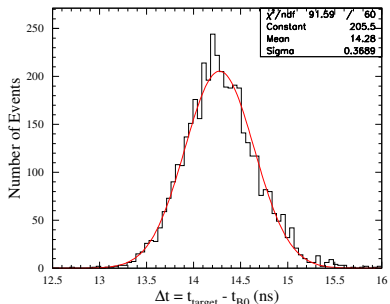
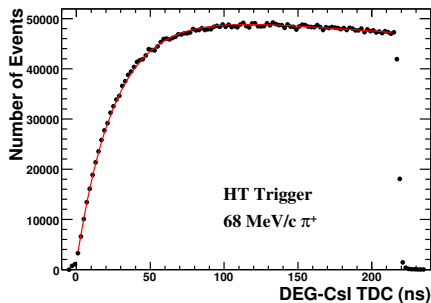
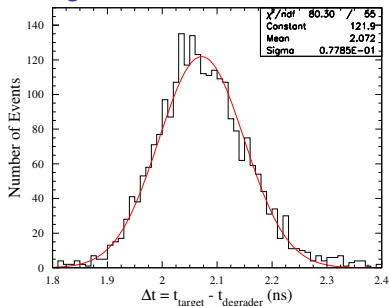

Sample waveforms 2007:

$\pi \rightarrow \mu \rightarrow e$
(in TGT)

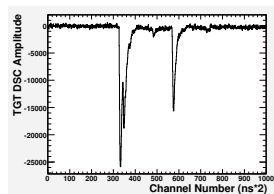
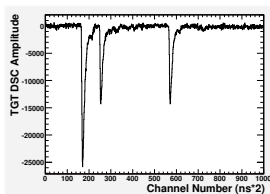

$\pi \rightarrow e$
(in TGT)

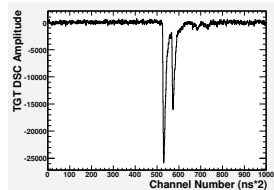
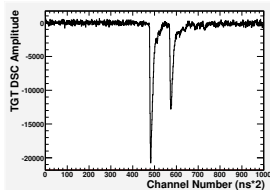

Beam π^+
(in DEG)

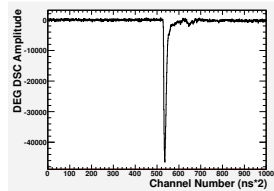
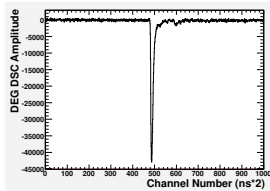

Waveforms

2008:

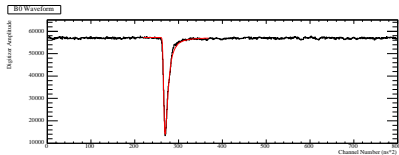

B0

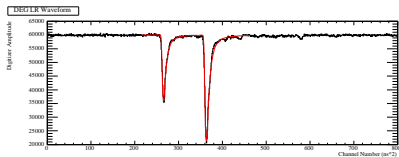

DEG-horiz

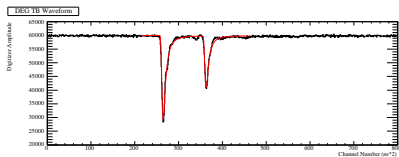

DEG-vert

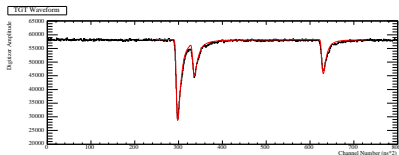

TGT

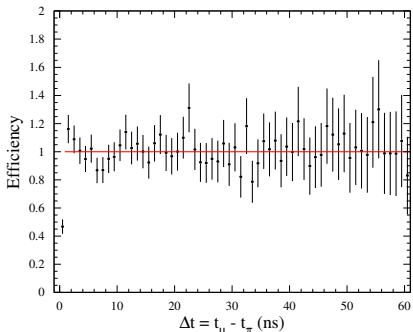
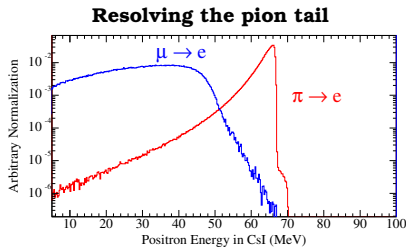
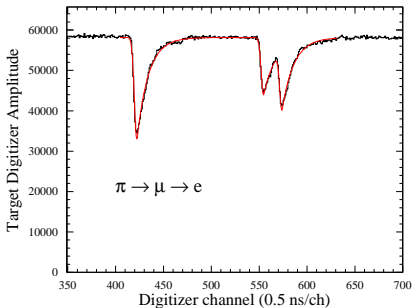
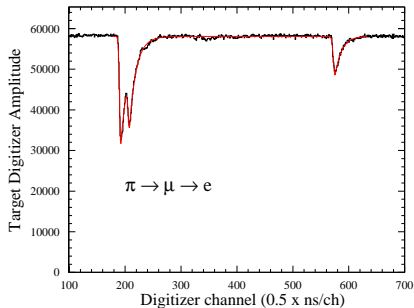

PEN Experiment: Present Status

- ▶ Stopped beam at $\sim 15,000 \pi^+/\text{sec}$.
- ▶ Pion decays detected in a 250 ns wide gate.
- ▶ Position sensitive two-piece wedged active degrader detector.
- ▶ Digitized signals of beam counters: forward (B0), active degrader (DEG), and active target (AT).
- ▶ Two development runs, in 2007 and 2008, ramping up beam stop and DAQ rates to design specifications.
- ▶ Total pions stopped in 2007 and 2008 runs: $> 8 \times 10^{10}$.
To date $> 4.7 \times 10^6 \pi \rightarrow e\nu$ decays recorded, corresponding to $(\delta B/B)_{\text{stat}} < 5 \times 10^{-4}$.
- ▶ Detailed data analysis under way in preparation for a 2009 run, planned to complete the required event statistics. Improved beam tracking with a miniTPC under design.

Web page: <http://pen.phys.virginia.edu>

Experiment R-05-01 (PEN) collaboration members:

L. P. Alonzi,^a V. A. Baranov,^c W. Bertl,^b M. Bychkov,^a Yu.M. Bystritsky,^c
 E. Frlež,^a N.V. Khomutov,^c A.S. Korenchenko,^c S.M. Korenchenko,^c
 M. Korolija,^f T. Kozlowski,^d N.P. Kravchuk,^c N.A. Kuchinsky,^c
 D. Mekterović,^f D. Mzhavia,^{c,e} A. Palladino,^a D. Počanić,^{a,*} P. Robmann,^g
 A.M. Rozhdestvensky,^c V.V. Sidorkin,^c U. Straumann,^g I. Supek,^f
 Z. Tsamalaidze,^e A. van der Schaaf,^{g,*} E.P. Velicheva,^c and V.V. Volnykh^c

^a*Dept of Physics, Univ of Virginia, Charlottesville, VA 22904-4714, USA*

^b*Paul Scherrer Institut, CH-5232 Villigen PSI, Switzerland*

^c*Joint Institute for Nuclear Research, RU-141980 Dubna, Russia*

^d*Institute for Nuclear Studies, PL-05-400 Swierk, Poland*

^e*IHEP, Tbilisi, State University, GUS-380086 Tbilisi, Georgia*

^f*Rudjer Bošković Institute, HR-10000 Zagreb, Croatia*

^g*Physik Institut der Universität Zürich, CH-8057 Zürich, Switzerland*